



Features:

- Single Set Point
- Multifunction: 1) On delay 2) Interval 3) Cyclic -on first 4) Cyclic -off first (user selectable)
- Start input
- Easy time setting
- Up / Down counting

Size: 1/16 DIN 48mm X 48mm

Technical Specifications

Input Specifications

Accuracy	±0.05% of F.S. or 50msec whichever is greater
Start Input	Gate / Pulse (Programmable)
Reset Input	a) Front panel (selectable) b) Remote reset c) On power interruption

Output Specifications

Output Contact	2 C/O
Relay Rating	5A @ 230V AC

Functional Specifications

Modes	ON delay / Interval delay Cyclic ON first / Cyclic OFF first
Time Ranges	0 - 9.99 sec 0 - 99.9 sec 0 - 999 sec 0 - 9.59 min : sec 0 - 99.9 min 0 - 999 min 0 - 9.59 hr : min 0 - 99.9 hr 0 - 999 hr
Counting Direction	Up / Down
Configuration Lock	Via rear terminals
Led Indication	Relay status
Mounting	Panel mounting
Time Setting	By keys on front panel

Supply Voltage

Supply Voltage	85 to 270V AC/DC (AC @ 50 / 60Hz)
----------------	-----------------------------------

Environmental Specifications

Temperature	Operating: 0 to 50°C Storage: -5 to 50°C
Humidity (non-condensing)	95% RH
Weight	179 gms

Dimensions

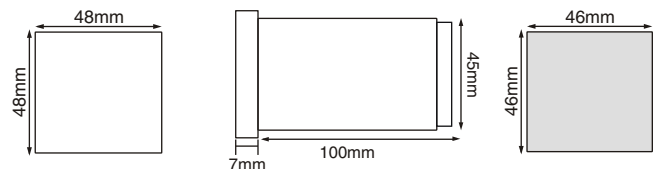

Terminal Connections

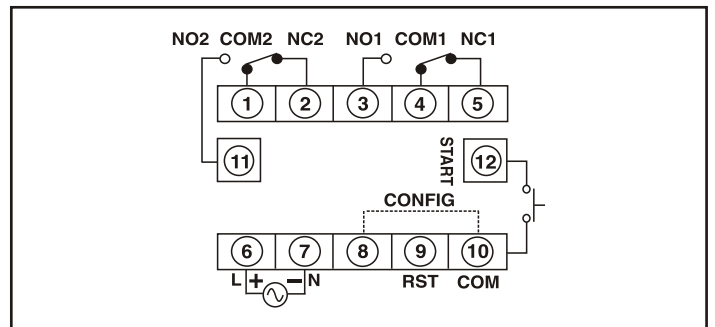

Ordering Information

Part No.	Memory Retention	Supply Voltage
XT520N	NO	85 to 270V AC/DC

Timing Diagram

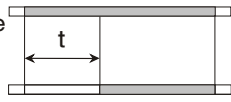
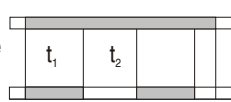
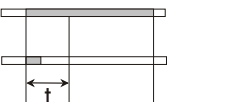
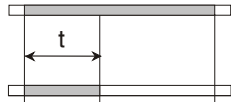
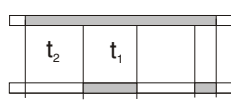
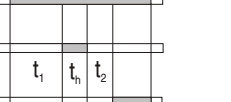
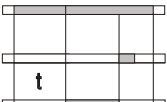
<p>Function : On delay</p> <p>Supply Voltage</p>  <p>NO Contact</p> <p>t = Set delay time</p>	<p>Function : Cyclic (On time first)</p> <p>Supply Voltage</p>  <p>NO Contact</p> <p>t₁= On time, t₂ = off time</p>	<p>Function : On delay-pulse start</p> <p>Supply voltage</p>  <p>Start Contact</p> <p>NO Contact</p> <p>t = Set delay time</p>
<p>Function : Interval delay</p> <p>Supply Voltage</p>  <p>NO Contact</p> <p>t = Set delay time</p>	<p>Function : Cyclic (Off time first)</p> <p>Supply Voltage</p>  <p>NO Contact</p> <p>t₁= On time, t₂ = off time</p>	<p>Function: Gate start-On delay</p> <p>Supply voltage</p>  <p>Gate Contact</p> <p>NO Contact</p> <p>t=delay time = t₁+ t₂, t_h = hold time</p>
<p>Function : Reset</p> <p>Supply Voltage</p>  <p>Reset Contact</p> <p>NO Contact</p> <p>t = Delay time</p> <p style="text-align: right;">reset</p>		